

Technical data sheet

Clamp clip, single, metal pressure trough, round profiles/
pipes

Item number: 1158317



Suitable for all round profile irons or pipes of diameters to 22 mm; clip, pressure trough and bolt made of steel, hot-dip galvanised; the metal troughs have strongly rounded edges on all sides, so that no damage to the cables need be feared.



St Steel

FT Hot-dip galvanised

Master data

Item number	1158317
Type	2056RS M 34 FT
Description 1	Clamp clip
Description 2	with metal pressure sump
Manufacturer	OBO
Dimension	28-34mm
Material	Steel
Surface	Hot-dip galvanised
Surface standard	DIN EN ISO 1461
Smallest sales unit	100
Unit of quantity	Piece
Weight	9 kg
Weight unit	kg/100 pc.

Technical data sheet

Clamp clip, single, metal pressure trough, round profiles/
pipes

Item number: 1158317



Dimensions

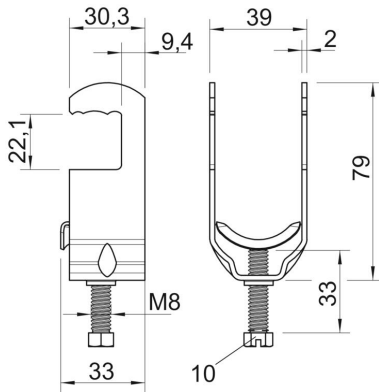

Dimension B	39 mm
Dimension C	33 mm
Dimension G (mm)	M8
Dimension H	79 mm
Dimension L	33 mm
Dimension t	2 mm

Technical data

Number of cables/pipes	1
For pipe diameter, max.	32 mm
For pipe diameter, min.	32 mm
Halogen-free	no
Max. Tightening torque	5 Nm
With plastic trough	no
With metal trough	yes
Mounting type	Round profile
Impact-resistant	no
Clamping range D, max.	34 mm
Clamping range D, min.	28 mm
Surface addition	hot galvanised
Material addition	Steel
With counter-trough	no
Material of trough	Steel