

Technical data sheet

External corner, for device installation trunking Rapid 45-2
type GK-53130

Item number: 6113220



External corner 90° for changing the direction of Rapid 45-2 device installation trunking.



PVC Polyvinylchloride

Master data

Item number	6113220
Type	GK-AS53130RW
Description 1	External corner
Description 2	rigid form
Manufacturer	OBO
Dimension	190x190x130
Colour	Pure white; RAL 9010
Material	Polyvinylchloride
Smallest sales unit	1
Unit of quantity	Piece
Weight	56.2 kg
Weight unit	kg/100 pc.

Technical data sheet

External corner, for device installation trunking Rapid 45-2
type GK-53130
Item number: 6113220



Dimensions

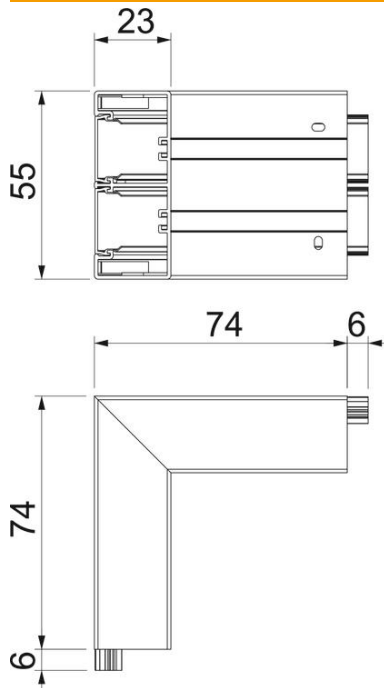

Length	74 mm
Width	130 mm
Height	53 mm

Technical data

Number of covers	2
Version for	Base and cover
for duct width	130 mm
for trunking height	53 mm
Halogen-free	no
Cable retaining clip	no
Duct connector	no
Cover mounting type	Internal
Mounting perforation in base	yes
Cover width	45 mm
Cover width 2	45 mm
Cover width 3	0 mm
Protection rating	IP40
Protective film	yes
Protection rating IK code	IK08
Symmetrical	yes
Permitted temperature range, max.	60 °C
Permitted temperature range, min.	-15 °C
Angle range, max.	90 mm
Angle range, min.	90 mm