

Technical data sheet

Wall and support bracket AW 15

Item no. 6420745

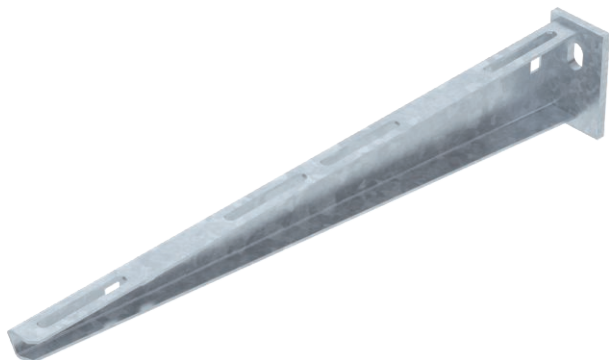

Light-duty wall and support bracket with welded head plate.

Fastening of the bracket to the U support of width 400 mm or greater using a hexagonal bolt through both sides of the support. Please insert suitable spacers.



St	Steel
FT	Hot-dip galvanised

Master data

Item no.	6420745
Type	AW 15 41 FT
Description 1	Wall and support bracket
Description 2	with welded head plate
Dimension	B410mm
Material	Steel
Material symbol	St
Surface	Hot-dip galvanised
Surface to DIN	DIN EN ISO 1461
Surface symbol	FT
Smallest sales unit (VG)	1 Piece
Weight	54,00 kg/100 pc.

Technical data

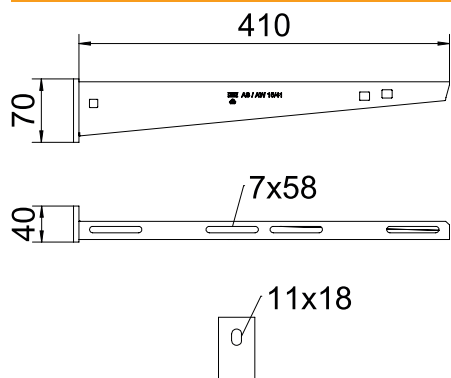

Width	410,00 mm
Side height	70,00 mm
Dimension A	40,00 mm
Dimension B	410,00 mm
Dimension H	70,00 mm
Dimension L	410,00 mm
Hole diameter	11,00 mm
Dimension value	410 x 70
Version	Wall and support brackets
Version	Wall and support bracket
EPD article	<input checked="" type="checkbox"/>
F in kN	1,50 kN
Suitable for maintaining electrical function	<input checked="" type="checkbox"/>
Rustproof steel, pickled	<input type="checkbox"/>
Angle range	90,00 - 90,00 °

Technical data sheet

Wall and support bracket AW 15

Item no. 6420745



Load charts



Load diagram, bracket, type AW 15

- 1 Bending of the bracket tip at permitted bracket load
- 2 Permitted bracket load in kN without man load
- Load curve with bracket lengths in mm

Characteristic anchor load values for wall bracket AW 15

Wall fastening		Max. load [kN]							
		Bracket width [mm]							
		110%	160	210	310	410	510	560	610
Anchor type									
BZ-U 8-10-21/75		1,50	0,90	1,30	0,65	0,55	2,40	0,45	0,45
BZ-U 10-10-30/90		1,50	1,50	1,40	1,50	0,95	0,85	1,30	1,30

Max. total load F = cable weight + cable tray + bracket. The load capacity values increase considerably when used in uncracked concrete. The values given are based on concrete of strength class C20/25. Observe the installation conditions of the DIBt approval (anchors).

Load values for AW 15 on suspended support

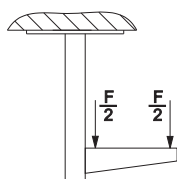

Load values for AW 15 on suspended support

Characteristic anchor load values for wall bracket AW 15

T1	Wall fastening								
T2		Max. load [kN]							
T3		Bracket width [mm]							
T4	Anchor type	110%	160	210	310	410	510	560	610
	BZ-U 8-10-21/75	1,5	0,9	1,3	0,65	0,55	2,4	0,45	0,45
	BZ-U 10-10-30/90	1,5	1,5	1,4	1,5	0,95	0,85	1,3	1,3